



Tabletop Vacuum Packaging

Models VP-NL-0004-S, 0008-S, 0016-S, 0021-S, 0016-LL

Items 50006, 50007, 50008, 50009, 50010

Instruction Manual



Revised - 02/25/2022



Toll Free: 1-800-465-0234
Fax: 905-607-0234
Email: service@omcan.com
www.omcan.com

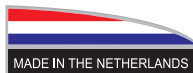

Table of Contents

Model VP-NL-0004-S / Model VP-NL-0008-S / Model VP-NL-0016-S
Model VP-NL-0021-S / Model VP-NL-0016-LL

Section	Page
General Information -----	3 - 4
Safety and Warranty -----	4 - 5
Technical Specifications -----	6
Installation -----	6 - 7
Operation -----	7 - 14
Maintenance -----	14 - 19
Troubleshooting -----	19 - 20
Parts Breakdown -----	21 - 24
Electrical Schematics -----	25
Notes -----	26
Warranty Registration -----	27



General Information

Omcan Manufacturing and Distributing Company Inc., Food Machinery of America, Inc. dba Omcan and Omcan Inc. are not responsible for any harm or injury caused due to any person's improper or negligent use of this equipment. The product shall only be operated by someone over the age of 18, of sound mind, and not under the influence of any drugs or alcohol, who has been trained in the correct operation of this machine, and is wearing authorized, proper safety clothing. Any modification to the machine voids any warranty, and may cause harm to individuals using the machine or in the vicinity of the machine while in operation.

CHECK PACKAGE UPON ARRIVAL

Upon receipt of an Omcan shipment please inspect for external damage. If no damage is evident on the external packaging, open carton to ensure all ordered items are within the box, and there is no concealed damage to the machine. If the package has suffered rough handling, bumps or damage (visible or concealed), please note it on the bill of lading before accepting the delivery and contact Omcan within 24 hours, so we may initiate a claim with the carrier. A detailed report on the extent of the damage caused to the machine must be filled out within three days, from the delivery date shown in the shipping documents. Omcan has no recourse for damaged products that were shipped collect or third party.

Before operating any equipment, always read and familiarize yourself with all operation and safety instructions.

Omcan would like to thank you for purchasing this machine. It's of the utmost importance to save these instructions for future reference. Also save the original box and packaging for shipping the equipment if servicing or returning of the machine is required.

Omcan Fabrication et distribution Compañie Limité et Food Machinery d'Amerique, dba Omcan et Omcan Inc. ne sont pas responsables de tout dommage ou blessure causé du fait que toute personne ait utilisé cet équipement de façon irrégulière. Le produit ne doit être exploité que par quelqu'un de plus de 18 ans, saine d'esprit, et pas sous l'influence d'une drogue ou d'acohol, qui a été formé pour utiliser cette machine correctement, et est vêtu de vêtements de sécurité approprié. Toute modification de la machine annule toute garantie, et peut causer un préjudice à des personnes utilisant la machine ou des personnes à proximité de la machine pendant son fonctionnement.

VÉRIFIEZ LE COLIS DÈS RÉCEPTION

Dès réception d'une expédition d'Omcan veuillez inspecter pour dommages externes. Si aucun dommage n'est visible sur l'emballage externe, ouvrez le carton afin de s'assurer que tous les éléments commandés sont dans la boîte, et il n'y a aucun dommage dissimulé à la machine. Si le colis n'a subi aucune mauvaises manipulations, de bosses ou de dommages (visible ou cachée), notez-le sur le bond de livraison avant d'accepter la livraison et contactez Omcan dans les 24 heures qui suivent, pour que nous puissions engager une réclamation auprès du transporteur. Un rapport détaillé sur l'étendue des dommages causés à la machine doit être rempli dans un délai de trois jours, à compter de la date de livraison indiquée dans les documents d'expédition. Omcan n'a aucun droit de recours pour les produits endommagés qui ont été expédiées ou cueilli par un tiers transporteur.

General Information

Avant d'utiliser n'importe quel équipement, toujours lire et vous familiariser avec toutes les opérations et les consignes de sécurité.

Omcan voudrais vous remercier d'avoir choisi cette machine. Il est primordial de conserver ces instructions pour une référence ultérieure. Également conservez la boîte originale et l'emballage pour l'expédition de l'équipement si l'entretien ou le retour de la machine est nécessaire.

Omcan Empresa De Fabricacion Y Distribucion Inc. Y Maquinaria De Alimentos De America, Inc. dba Omcan y Omcan Inc. no son responsables de ningun daño o perjuicio causado por cualquier persona inadecuada o el uso descuidado de este equipo. El producto solo podra ser operado por una persona mayor de 18 años, en su sano juicio y no bajo alguna influencia de droga o alcohol, y que este ha sido entrenado en el correcto funcionamiento de esta máquina, y ésta usando ropa apropiada y autorizada. Cualquier modificación a la máquina anula la garantía y puede causar daños a las personas usando la máquina mientras esta en el funcionamiento.

REVISE EL PAQUETE A SU LLEGADA

Tras la recepcion de un envio Omcan favor inspeccionar daños externos. Si no hay daños evidentes en el empaque exterior, Habra el carton para asegurarse que todos los articulos solicitados estén dentro de la caja y no encuentre daños ocultos en la máquina. Si el paquete ha sufrido un manejo de poco cuidado, golpes o daños (visible o oculto) por favor anote en la factura antes de aceptar la entrega y contacte Omcan dentro de las 24 horas, de modo que podamos iniciar una reclamación con la compañía. Un informe detallado sobre los daños causados a la máquina debe ser llenado en el plazo de tres días, desde la fecha de entrega que se muestra en los documentos de envío. Omcan no tiene ningun recurso por productos dañados que se enviaron a recoger por terceros.

Antes de utilizar cualquier equipo, siempre leer y familiarizarse con todas las instrucciones de operación y seguridad.

Omcan quisiera darles las gracias por la compra de esta máquina. Es de la máxima importancia para guardar estas instrucciones para referencias en el futuro. También guarde la caja original y el embalaje para envío del equipo si el mantenimiento o la devolución de la máquina es necesaria.

Safety and Warranty

The manufacturer of this equipment accepts no liability whatsoever for damage or injury caused by failing to adhere to the directions and instructions in this manual, or through carelessness during the installation, use, maintenance and repair of the machine identified on the front of this document, or any of its accompanying options or components.

The owner of the machine is fully responsible at all times for the adherence to the locally applicable safety regulations and guidelines. Obey all safety instructions and guidelines as provided in this manual.



Safety and Warranty

INTENDED USE OF THE MACHINE

The machine is designed for vacuum packaging of food or other products for 8 hours a day, 5 days a week. Any other or extended use is not in accordance with this purpose and the manufacturer accepts no liability for any resulting damage or injury. Only use this machine while in perfect technical condition in accordance with the above mentioned purpose.

Safety Measures

The machine is equipped with the following standard safety devices:

- Short-circuit and overload safety.
- Pump fan guards.

All safety devices must be correctly installed and may only be removed to accommodate maintenance and repair activities by trained and authorized service personnel. The machine may never be operated while safety measures are incomplete, deactivated or absent. The safety devices may never be by-passed.

RESIDENTIAL USERS: Vendor assumes no liability for parts or labor coverage for component failure or other damages resulting from installation in non-commercial or residential applications. The right is reserved to deny shipment for residential usage; if this occurs, you will be notified as soon as possible.

1 YEAR PARTS AND LABOR WARRANTY

Within the warranty period, contact Omcan Inc. at 1-800-465-0234 to schedule an Omcan authorized service technician to repair the equipment locally.

Unauthorized maintenance will void the warranty. Warranty covers electrical and part failures, not improper use.

Please see <https://omcan.com/disclaimer> for complete info.

WARNING:

The packaging components are classified as normal solid urban waste and can therefore be disposed of without difficulty.

In any case, for suitable recycling, we suggest disposing of the products separately (differentiated waste) according to the current norms.

DO NOT DISCARD ANY PACKAGING MATERIALS IN THE ENVIRONMENT!

Technical Specifications

11" VACUUM PACKAGING MACHINES

Model	VP-NL-0004-S	VP-NL-0008-S
Seal Length	11" / 279mm	
Vacuum Pump	4 m ³	8 m ³
10 Programmable Control	No	
Maximum Product Height	4.3" / 110mm	
Useful Chamber Size	12.2" x 11" x 4.3" / 310 x 279 x 110mm	
Power Consumption	0.4 - 0.5 kW	
Electrical	100 - 120V / 60Hz / 1	
Weight	55 lbs. / 25 kgs.	
Dimensions	19.7" x 14.4" x 13.4" / 500 x 365 x 340mm	
Item Number	50006	50007

16.5" VACUUM PACKAGING MACHINES

Model	VP-NL-0016-S	VP-NL-0021-S	VP-NL-0016-LL
Seal Length	16.5" / 419mm		16.5" / 419mm (x2)
Vacuum Pump	16 m ³	21 m ³	16 m ³
10 Programmable Control	No	Yes	No
Maximum Product Height	7" / 178mm		
Useful Chamber Size	14.6" x 16.5" (max) x 7" / 371 x 419 (max) x 178mm		
Power Consumption	0.7 - 1.3 kW		
Electrical	100 - 120V / 60Hz / 1		
Weight	132 lbs. / 60 kgs.		
Dimensions	21.9" x 20.7" x 18.1" / 555 x 525 x 460mm		
Item Number	50008	50009	50010

Installation

GENERAL

- Level the machine on a flat firm surface.
- Position the machine in such a manner that the pump is unobstructed and properly ventilated.
- Engage the locks on the wheels, if so equipped.
- Check the oil level in the pump; add oil if necessary.

Installation

Never operate the machine when the oil level is low. It is recommended to change the oil at least every 2 months.

TURNING ON MACHINE

- If so equipped, like some mobile and double-chamber models, turn on the main power switch on the back of the machine.
- Push the on/off button on the control panel of the machine.

GAS CONNECTION FOR MAP APPLICATIONS (MODIFIED ATMOSPHERIC PACKAGING)

- Connect the gas supply line to the inlet on the back of the machine.
- Maximum pressure: 1 bar.
- Anchor the gas cylinders securely to prevent them from falling over.
- Make sure that the work area is well-ventilated.
- To assure that you use the appropriate gas for your application, consult your dealer or gas supplier.
- Assure a good connection and use high-quality materials.

COMPRESSED AIR CONNECTION FOR ADDITIONAL SEALING PRESSURE

- Additional sealing pressure is usually recommended for MAP applications only.
- The M40-M80 and the L10-L60 models with the option Gas/MAP are standard equipped with a compressed air inlet.
- Extra sealing pressure is not necessary and not available for the Table-Top, M10, M20, M30.
- Consult your dealer for installation details.
- Maximum pressure: 1 bar.
- Assure a good connection and use high-quality connector.

Operation

DIGITAL CONTROL WITH LCD DISPLAY

Some Henkovac vacuum machines have a control system with just one Program (P1). Other machines have an optional expanded control system, which can accommodate up to 9 custom programs (P1-9).

ONE-PROGRAM CONTROL SYSTEM

Henkovac machines with the One-Program control system can be programmed for the following 2 functions:

1. Vacuum time (seconds).
 2. Sealing time (seconds).
- The values for vacuum and sealing times are selected by the user and saved in program P1.
 - During operation, the LCD display will show symbols to indicate the active function and the progress of the packing cycle.



















Operation







- The actual vacuum pressure is indicated by the analog vacuum gauge.

PLUG AND PLAY

- When turning on the machine for the first time:
 - Running time of the vacuum pump is pre-set at 30-40 seconds and the sealing time at 2 seconds. Vacuum is indicated on the analog vacuum gauge.
- When turning on the machine after that, program P1 will contain the most-recently used settings.
- The vacuum and sealing times are easily adjusted to match the needs for the application.

OPERATING THE MACHINE WITH ONE-PROGRAM CONTROL SYSTEM

	<p>On: Turns the machine on:</p> <ul style="list-style-type: none"> The machine will start up in the most-recently used program. The pump of a machine with a transparent cover will start when the cover is closed. <p>Off: Turns the machine off:</p> <ul style="list-style-type: none"> When pressing the  button once, the  symbol will start blinking and the pump will stop after about 4 seconds. When pressing the  button a second time, the pump will stop immediately. Closing the cover will initiate the cool-down phase; the machine will complete a number of vacuum cycles before turning off automatically.
	<p>Stop-function:</p> <ul style="list-style-type: none"> Stops the machine at any point in the packing cycle and aerates the chamber. <p>Reset-function:</p> <ul style="list-style-type: none"> While programming, resets the program value to its original setting. Press the menu button  to return to the Home menu
	<p>Stops the current function and initiates the next step in the cycle:</p> <ul style="list-style-type: none"> By pressing the  of the sealing button , the vacuum function stops and the program jumps to the sealing function. While packing sauce or soup, the package may be sealed as soon as product boiling is detected.
	<p>Entering the desired vacuum time  : By pressing the + or – of the vacuum button, the vacuum time can be increased or decreased.</p> <p>The selected value is confirmed and saved by pressing the menu button  :</p> <ul style="list-style-type: none"> Press the  button to reset the original value.
	<p>Entering the desired sealing time  : By pressing the + or – of the sealing button, the sealing time can be increased or decreased.</p> <p>The selected value is confirmed and saved by pushing the menu button  :</p> <ul style="list-style-type: none"> Press the  button to reset the original value.
	<p>Menu Button:</p> <ul style="list-style-type: none"> Confirms and saves the entered values for vacuum and sealing times. Returns to the Home menu.

	<p>When turning off the machine with the  button, the  symbol will start blinking:</p> <ul style="list-style-type: none"> • The pump will stop after about 4 seconds. • Press the  button a second time and the pump will stop immediately. • Close the lid; the machine initiates the cool-down phase and perform a number of vacuum cycles before turning off automatically. • These additional cycles allow any moisture in the oil of the pump to evaporate. This increases the longevity of the machine and minimizes the need for oil changes and pump maintenance.
	<p>Service Symbol:</p> <ul style="list-style-type: none"> • After a number of operating hours or packing cycles, the service symbol will briefly appear on the display when the machine is turned on. In addition, the display indicates how many hours or cycles remain before an oil change is required. • Except for regularly changing the oil in the pump (important!), the machine requires little other routine maintenance. • To reset the service interval counters after the oil change: Start machine  and while the display shows the hours or cycles, press and hold the  button.

TEN-PROGRAM CONTROL SYSTEM

In addition to vacuum and sealing times, Henkovac machines with a Ten-Program control system may be programmed for several additional functions. Each of the 9 customizable programs is either:

1. Time controlled.
2. Sensor controlled.

TIME-BASED OPERATION (VACUUM GAUGE: MBAR)

- The values for vacuum and sealing time, as well as the values for several optional functions, are selected by the customer and saved in any of 9 customizable programs P1-9.
- When operating a packaging machine with a time-based program, the actual vacuum pressure is indicated by the analog vacuum gauge. The number of seconds of vacuum time remaining is shown on the LCD display.

PLUG AND PLAY

- When turning on a time-based machine for the first time, it will start up in the PA program AUTOMATIC. This is a pre-set factory program with 30-40 seconds vacuum time and 2 seconds of sealing time.
- When turning on the machine after that, it will start up in the most-recently used program.

OPTIONAL INSTALLATION OF A SENSOR OR SOFT-AIR

- A machine with a time-based control program can be upgraded to sensor-based operation at a later date by installing the optional sensor kit.
- The Soft-Air feature can also be installed at a later date by ordering the optional soft-air kit.

SENSOR-BASED OPERATION (DIGITAL DISPLAY: MBAR)

- When operating a packaging machine with a sensor-based program, the actual vacuum pressure is digitally shown on the LCD display in mbar (standard setting) or in % vacuum.

Operation

















PLUG AND PLAY



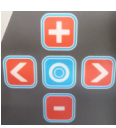

- When turning on a sensor-based machine for the first time, it will start up in the PA program AUTOMATIC. This is a pre-set factory program with 5 mbar of vacuum and 2 seconds of sealing time.
- When turning on the machine after that, it will start up in the most-recently used program.

OPTIONAL INSTALLATION OF SOFT-AIR

- The Soft-Air feature can also be installed at a later date by ordering the optional soft-air kit.

OPERATING THE MACHINE WITH TEN-PROGRAM CONTROL SYSTEM

	<p>On: Turns the machine on:</p> <ul style="list-style-type: none"> • The machine will start up in the most-recently used program. • The pump of a machine with a transparent cover will start when the cover is closed.
	<p>Off: Turns the machine off:</p> <ul style="list-style-type: none"> • When pressing the  button once, the  symbol will start blinking and the pump will stop after about 4 seconds. • When pressing the  button a second time, the pump will stop immediately. • Closing the cover will initiate the cool-down phase. • The machine will complete a number of vacuum cycles before turning off automatically.
	<p>Stop-function:</p> <ul style="list-style-type: none"> • Stops the machine at any point in the cycle and aerates the chamber. <p>Reset-function:</p> <ul style="list-style-type: none"> • While programming, resets the program value to its original setting. • Press the menu button  to return to the Home menu. <p>Back function:</p> <ul style="list-style-type: none"> • While reviewing programmed values, returns to the previous selection.
	<p>Stops the active function and initiates the next step in the cycle:</p> <ul style="list-style-type: none"> • While the machine is running, exits the active function and jumps to the next step in the cycle. • While packing sauce or soup, the package may be sealed as soon as product boiling is detected.
	<p>Menu Button:</p> <ul style="list-style-type: none"> • Toggles between Home menu  and Settings menu . • Save Function: During programming, confirms and saves the entered program values and returns to the Home menu. • Return Function: Returns to the Home menu.
	<p>Review program values:</p> <ul style="list-style-type: none"> •   Cycles through programs P1 to P9, as well as PA and P H2O. •  Displays the programmed value for each function; the function being reviewed will be blinking. •   Displays the value for the next function. •  Returns to the Home menu.

	<p>Adjust program values and turn functions ON/OFF:</p> <ul style="list-style-type: none"> • Forward or back; adjusted values are saved right away. • Increases or decreases function values. • Turns functions ON/OFF; specific functions, like soft-air, clean cut seal, etc., are turned either on or off. • If the function is turned on, the value may be adjusted by pressing the and buttons. • Resets the original value. • Saves changes and returns to the Home menu.
	<p>Multi-Functional button: Performs various functions, depending on the active menu:</p> <p>Home menu :</p> <ul style="list-style-type: none"> • No effect while in the PA program. • For programs P1-9, displays the entered values. <p>Settings menu :</p> <ul style="list-style-type: none"> • For specific functions, like soft-air, clean cut seal etc., the button is used to turn the function ON/OFF.
<p>P1 – P9</p>	<p>Programs 1 through 9:</p> <ul style="list-style-type: none"> • Each program may be customized by turning certain functions on or off and by adjusting the function values.
<p>PA AUTOMATIC</p>	<p>PA - Automatic:</p> <ul style="list-style-type: none"> • Program with factory settings for vacuum and sealing functions, which is activated when turning on the machine for the first time.
<p>P H₂O</p>	<p>P H₂O – Program:</p> <ul style="list-style-type: none"> • To be used when packing liquids or semi-liquids, like sauces and soups. • Program jumps to the sealing function as soon as product boiling is detected; this prevents product loss through spillage and evaporation.
	<p>When turning off the machine with the button, the symbol will start blinking on the LCD display:</p> <ul style="list-style-type: none"> • The pump will stop after about 4 seconds. • Press the button for a second time and the pump will stop immediately. • Close the lid; the machine will initiate the cool-down phase and perform a number of vacuum cycles before turning off automatically. • These additional cycles allow any moisture in the oil of the pump to evaporate. This increases the longevity of the machine and minimizes the need for oil changes and pump maintenance.
	<p>Service Symbol:</p> <ul style="list-style-type: none"> • After reaching a certain number of operating hours or packing cycles, the service symbol will briefly appear on the display when turning on the machine. In addition, the display indicates how many hours or cycles remain before an oil change is required. • Except for regularly changing the oil in the pump, the machine requires little other routine maintenance. • After reaching the service limit, the display will indicate the negative number of exceeded operating hours or cycles. • To reset the service interval counters after the oil change: Start machine and while the display shows the hours or cycles, press and hold the button to reset.

Operation

PROGRAMMING THE MACHINE

ONE-PROGRAM CONTROL SYSTEM



- The One-Program control system is standard on the S20, S30, S40, S50, M10, M30 (with 21m³ pump).
- The One-Program control system is time-based.
- The Ten-Program control system (time or sensor) is optional for these models, except for S20.

THE ONE-PROGRAM CONTROL SYSTEM PROVIDES ONLY ONE PROGRAM (P1)

- There is no memory to store additional values.
- The machine starts with the values that were most-recently used.
- The pump starts upon closing of the cover and stops when it is reopened.

PROGRAMMABLE FUNCTIONS





The following function values may be customized for P1:

-  Vacuum time: in seconds.
-  Sealing time: in seconds.





PROGRAMMING

1. Turn the machine on by pressing the on/off button.
 - a. The factory setting for the vacuum time is 30-40 seconds.
 - b. The factory settings for the seal time is 2 seconds.





REVIEWING VACUUM TIME AND SEALING TIME

1. Press the  button to display the programmed vacuum time the vacuum time is pre-set at the factory.

2. Press the  button to display the programmed sealing time the sealing time is pre-set at the factory at 2 seconds.





ADJUSTING VACUUM TIME FOR P1

1. Press twice on the  or  button.
 - After pressing once, the programmed value is displayed.
 - After pressing twice, the  symbol will start blinking and the value may be adjusted.
2. Save the new value by pressing the menu button.
3. To retain the original value, press the  button.
4. Exit the program by pressing the menu button.

ADJUSTING SEALING TIME FOR P1

1. Press twice on the  or  button.
 - After pressing once, the programmed value is displayed.
 - After pressing twice, the  symbol will start blinking and the value may be adjusted.
2. Save the new value by pressing the menu button.
3. To retain the original value, press the  button.
4. Exit the program by pressing the menu button.

TURNING OFF MACHINE







1. Turn the machine off by pressing the  button.
2. The  symbol on the display will start blinking.
3. Push the  button a second time and the pump will stop immediately.
4. If no action is taken the pump turns off after 4 seconds.
5. Close the cover and the machine will initiate the cool-down phase and perform a number of vacuum cycles while the cover stays closed and the machine will turn off automatically after about 15 minutes.
 - These cycles are necessary to cool down the machine and to allow any moisture in the oil of the pump to evaporate.

TEN-PROGRAM CONTROL SYSTEM







- The Ten-Program control system is standard time-based on the M20, M40-M80, L01-L60.
 - Sensor-based operation is an option, which can be installed at a later date.
- The Ten-Program control system provides:
 - 9 customizable programs (P1-P9).
 - Program PA; this is an - Automatic Program – Pre-set at the factory at a vacuum time of 30-40 seconds (or 5 mbar for a sensor-based program) and a sealing time of 2 seconds.
- Program P H₂O for liquid products.
 - When turning on the machine, the pump will start. After about 15 minutes of inactivity, the pump will stop automatically.

PROGRAMMABLE FUNCTIONS

The following functions may be customized for each program P1-P9:

-  **Vacuum time:** in seconds or mbar (only with sensor).
-  **Sealing time:** in seconds.
-  **Vacuum Plus:** on/off, in seconds.
-  **Gassing:** on/off, in seconds or mbar (only with sensor).
-  **Clean Cut Controlled (CCC) Seal:** on/off, in seconds.
-  **Soft-Air:** on/off, in seconds or mbar (only with sensor).
-  **Multi-cycle:** on/off, in number of cycles.





REVIEWING FUNCTION VALUES FOR P1-P9

1. Turn the machine on by pushing the  button.
2. The most-recently used program will be indicated.
3. All selected functions for this program are indicated at the bottom of the display.
4. To review the values for these functions, push the  button; use the    button to display each function value.
5. The values cannot be changed; this can only be done in the Settings menu.
6. Push the  button to return to the Home menu.

PROGRAMMING AND ADJUSTING VALUES FOR P1-P9





1. Select the program to be set up or adjusted.

Operation





2. Push the menu button to access the Settings menu.
3. All functions for the selected program are indicated at the bottom of the display.
4. Push the  button to select the blinking function to be adjusted.
5. Adjust the value of the selected function with the  button.
6. Press the  button to reset all functions to their original values.
7. Select the next function with the  button.
8. Press the menu button to save the entered values and to return to the Home menu.

TURNING PROGRAM FUNCTIONS ON/OFF

The following functions can be turned ON/OFF for each program P1-P9:

-  **Vacuum Plus:** on/off, in seconds.
-  **Gassing:** on/off, in seconds or in mbar (only with sensor).
-  **Clean Cut Controlled (CCC) Seal:** on/off, in seconds.
-  **Soft-Air:** on/off, in seconds or in mbar (only with sensor).
-  **Multi-cycle:** on/off, in number of cycles.

ADJUSTING ON/OFF FUNCTION VALUES

1. Press the menu button to select the Settings menu.
2. Use the  button to select the blinking function to be adjusted.
3. Press the  button to select the desired value.
4. Press the  button to reset all functions to their original values.
5. Select the next function with the  button.
6. Push the menu button to store all selected values and to return to the Home menu.

TURNING OFF MACHINE

- Follow the same procedure as for the One-Program control system.

Maintenance

GENERAL

Regular maintenance prevents equipment malfunctions and prolongs the life of the machine. In addition, it optimizes sanitary conditions.

- Always have a certified Henkovac dealer carry out repair and maintenance activities.

WARNING

- During maintenance activities, always turn the machine off at the main switch and/or unplug it from the electrical outlet.



ATTENTION

Observe the recommended service intervals. Overdue maintenance may lead to costly repairs and overhauls, and may void the equipment warranty.



- After reaching a programmed number of operating hours or packing cycles, the service symbol  will briefly appear on the display when the machine is started up. In addition, the display will indicate how many hours or cycles remain before an oil change is required.
- After passing the service limit, the display will indicate the negative number of excess operating hours or cycles.

VACUUM PUMP

To protect the vacuum pump, proper maintenance is important. Carry out the following tasks carefully:

- Check the vents and clean as necessary before turning on the machine to assure proper cooling of the pump.
- When the air filter is saturated with oil, an oil mist may be expelled; replacement of the filter is required.
- Use the cool-down/dehumidification feature. When turning off the machine  and closing the cover , the pump continues to run for some time. Any moisture in the oil of the pump will evaporate during this phase. This increases the longevity of the machine and minimizes the need for oil changes and pump maintenance.
- Check the oil level regularly and add as needed.
- Change the oil when the service symbol  appears on the display.

NOTE

To reset the service interval counters after the oil change: Start machine  and while the display shows the hours or cycles, press and hold the  button.

ADDING AND CHANGING THE PUMP OIL

WARNING

The operating temperature of the pump is 70° C / 158° F or higher. Wear gloves when servicing the pump or let it cool off sufficiently to prevent injuries.

ADDING OIL

1. Remove the oil filler cap
2. Add oil up to the maximum-level mark; use oil according to DIN 51506, lubrication oil group VC. When in doubt, consult your dealer.
3. Replace the oil filler cap.
4. After several packing cycles, check the oil level and add as needed.

CHANGING OIL

1. Remove the oil drain plug and drain the oil.
2. Replace the drain plug.
3. Remove the oil filler cap.
4. Add the correct oil up to the maximum-level mark.
5. Replace the oil filler cap.

Maintenance

6. To reset the service interval counters after the oil change: Start machine and while the display shows the hours or cycles, press and hold the  button.

NOTE

Collect the oil to have it processed and recycled according to the locally applicable regulations.

SEAL BEAMS AND COUNTER BEAMS

To achieve a quality seal, it is necessary that the seal beam and counter beam are in good condition.

1. Clean the seal and counter beams daily with a dry cloth.
2. Replace the Teflon tape on the seal beam if damaged and replace the sealing wire if kinked.
3. Replace the silicone rubber seal if it is burned in.

Depending on the type of machine, there are three seal beam versions:

1. Single-seal beam (T2).
2. Stainless steel seal beam.
3. Aluminum seal beam.

SINGLE-SEAL BEAM

REMOVE THE SEALING WIRE AND TEFLON TAPE AS FOLLOWS:

1. Grab the seal beam in the middle and pull it straight up and out of the machine.
2. The beam is held in place by 2 pins; some force may be necessary to loosen the beam.
3. Remove the brown Teflon tape that is applied to the seal beam.
4. Remove the two screws on the underside of the seal beam; this releases the sealing wire.
5. Clean the seal beam thoroughly and remove any glue residue off the Teflon tape.

NOTES

- Check the condition of the tensioning springs at both ends of the seal beam; replace if necessary.
- These springs maintain tension on the sealing wire.
- Using the seal beam without the springs may cause sealing wires to break.

INSTALL THE SEALING WIRE AND TEFLON TAPE AS FOLLOWS:

1. Position the sealing wire across the beam and fasten it on one side with a small bolt.
2. Apply tension on the wire by pulling it with a pair of pliers.
3. Fasten the wire on the opposite end of the beam with the second bolt and cut the wire to length; the ends of the sealing wire must be long enough to make electrical contact with the pins in the vacuum chamber.
4. Apply the Teflon tape smooth and tight over the seal beam; make sure that the beam is clean and free of grease.
5. Re-install the beam in the vacuum chamber; check to make sure that the ends of the sealing wire make contact with the steel pins.

ALUMINUM/STAINLESS STEEL SEAL BEAM

REMOVE THE SEALING AND CUTTING WIRES AS FOLLOWS:

1. Remove the old wires by pulling them loose from the seal beam contacts.
2. Loosen the clamp screws and remove the seal beam from the U-profile.
3. Remove the Teflon tape from the seal beam.
4. Remove the mounting plates on both ends of the seal beam by loosening the screws; this releases the sealing wires and/or sealing and cutting wires.
5. Clean the seal beam thoroughly.

NOTES

- After removal of the wires, check the strips of fiber glass for damage; replace if necessary.
- Check the condition of the tensioning springs at both ends of the seal beam; replace if necessary.
- Using the seal beam without the springs may cause the sealing wires to break.
- Check contact plate for damage; replace if necessary.

INSTALL THE SEALING AND CUTTING WIRES AS FOLLOWS:

1. If necessary, install new strips of fiber glass on the seal beam.
2. Insert the new wires behind one of the mounting plates and tighten the screws; make sure that the end of the wires line up with the bottom edge of the mounting plate.
3. Position the wires across the seal beam and loosely install the second mounting plate.
4. Carefully clamp the seal beam upside down in a bench vice.
5. Pull the wires as tightly as possible with a pair of pliers and secure the second mounting plate by tightening the screws.

NOTE

1. The wires can be further tightened by slightly loosening the screws of one of the mounting plates.
2. Pull the wires one-by-one tighter with a pair of pliers.
3. Re-tighten the screws after the correct tension has been achieved.
4. Cut the end of the wires flush with the bottom edge of the mounting plate.
5. Apply the Teflon tape smooth and tight over the seal beam without creases. Make sure that the beam is clean and free of grease.
6. Re-install the seal beam in the vacuum chamber and re-connect the wires.

ALUMINUM T-SHAPED SEAL BEAM

REMOVE THE SEALING WIRES AS FOLLOWS:

1. Remove the seal beam from the machine.
2. Remove the Teflon tape.
3. Loosen the screws on both sides of the beam; this will release the sealing wires.
4. Clean the seal beam thoroughly.

INSTALL THE SEALING WIRES AS FOLLOWS:

1. Apply new fiber glass to the beam if necessary.
2. Place new wires on the beam and fasten them on one side with mounting plates; tighten the screws.

Maintenance

3. Position the wires across the beam.
4. Fasten mounting plates; tighten screws.
5. Carefully clamp the beam in a bench vice.
6. Pull the wires as tightly as possible with a pair of pliers.
7. Secure the mounting plates with the screws.

NOTES

- Check the strip of fiber glass for damage and replace if necessary.
- Check the springs and replace if necessary.
- Using the seal beam without the springs may cause the sealing wires to break.

APPLYING TEFLON TAPE TO SEAL BEAM

1. Position the new Teflon tape on the seal beam and cut out the corners.
2. Remove the protective backing from the Teflon tape.
3. Apply the new tape to the seal beam; the tape has an adhesive strip on both sides.
4. Slide the seal beam onto the pins in the vacuum chamber (machines with transparent cover).
5. Slide the seal beam in the holder of the cover, tighten the mounting screws, and re-connect the wires (machines with metal cover).

NOTE

- The Teflon tape must not adhere to the tension blocks.

REPLACING SILICONE RUBBER SEAL OF COUNTER BEAM

The rubber seal is clamped in the counter beam. Replace the counter beam seal as follows:

1. Pull the old rubber seal from the groove in the counter beam.
2. Clean the groove.
3. Evenly press the new rubber seal into the groove and make sure that it does not stick out at either end of the counter beam.

RUBBER SEAL OF VACUUM CHAMBER COVER

To assure that the vacuum chamber is properly sealed, it is important that the rubber seal is in good condition and is not damaged. Replace the cover seal as follows:

1. Copy the length of the original rubber seal.
2. Pull the original rubber seal from the groove.
3. Clean the groove.
4. Evenly press the rubber seal into the groove; position the ends of the seal tightly against each other to prevent leakage.

STRUTS, DAMPERS AND SPRINGS

- Machines with transparent covers are equipped with gas struts to open the cover.
- Machines with metal covers are equipped with oil dampers and springs to open the cover.
- Have the struts, dampers and springs checked by your dealer once every 5 years and have them replaced as necessary.
- Have the gas struts replaced if the lid no longer opens properly.

VACUUM HOSES AND TUBES

- Check the vacuum hoses and tubes for kinks, tears and porosity; replace if necessary.

Troubleshooting

Fault/Symptom	Possible Cause	Remedy
Machine does not work.	The machine is not plugged in.	Plug the machine into the electrical outlet.
	The ground fault safety in the electrical panel has tripped.	Check the electrical panel.
	A fuse in the electrical panel is faulty.	Check the electrical panel.
	A fuse in the machine is faulty.	Consult your dealer.
	The motor protection of the machine is switched off.	Consult your dealer.
The vacuum pump does not run at full speed.	The oil is too thick or contaminated.	Change the oil.
	The pump motor runs on two phases.	Check the voltage; if correct, consult your dealer.
The vacuum in the package is insufficient.	The programmed vacuum value is too high.	Lower the vacuum value in the program.
	The packaging material is of poor quality.	Select a better-quality packaging material.
	The product damages the bag.	Program a higher value for Soft-Air.
	The machine gases the package.	Turn off the gassing function.
The seal is leaking.	The package seam is poorly formed.	Increase the sealing time and/or reduce the MAP gas pressure.
	The package seam is burnt.	Decrease the sealing time.
	The opening of the vacuum bag is contaminated.	Try again and make sure that the opening of the bag stays clean.
	The sealing beam is dirty.	Clean the sealing beam.
	The Teflon lining of the sealing beam is damaged.	Replace the Teflon lining.
	The silicon rubber seal in the counter beam is damaged.	Replace the silicon rubber seal.

Troubleshooting

There is not enough gas in the bag.	The bag is too small.	Select a bigger bag.
	The programmed gas level is too low.	Increase the gas level value.
	The bag is not correctly positioned over the gas outlets.	Adjust the bag position.
The machine does not seal.	The bag is not correctly positioned over the sealing beam.	Adjust the bag position.
	The sealing wire is broken.	Replace the sealing wire.
	The thermal safety of the power supply was tripped.	Wait until the safety resets, which can take half an hour. Decrease the sealing time.
	The electrical contacts of the seal beam have fouled.	Remove the seal beam and clean the pins and contacts with sand paper.
The service symbol appears when turning on the machine, indicating the remaining production hours or cycles.	The service interval counters have reached their maximum programmed values.	To reset the service interval counters after the oil change: Start the machine and while the display shows the hours or cycles, press and hold the "X" button.

Parts Breakdown

Model VP-NL-0004-S 50006

Model VP-NL-0008-S 50007

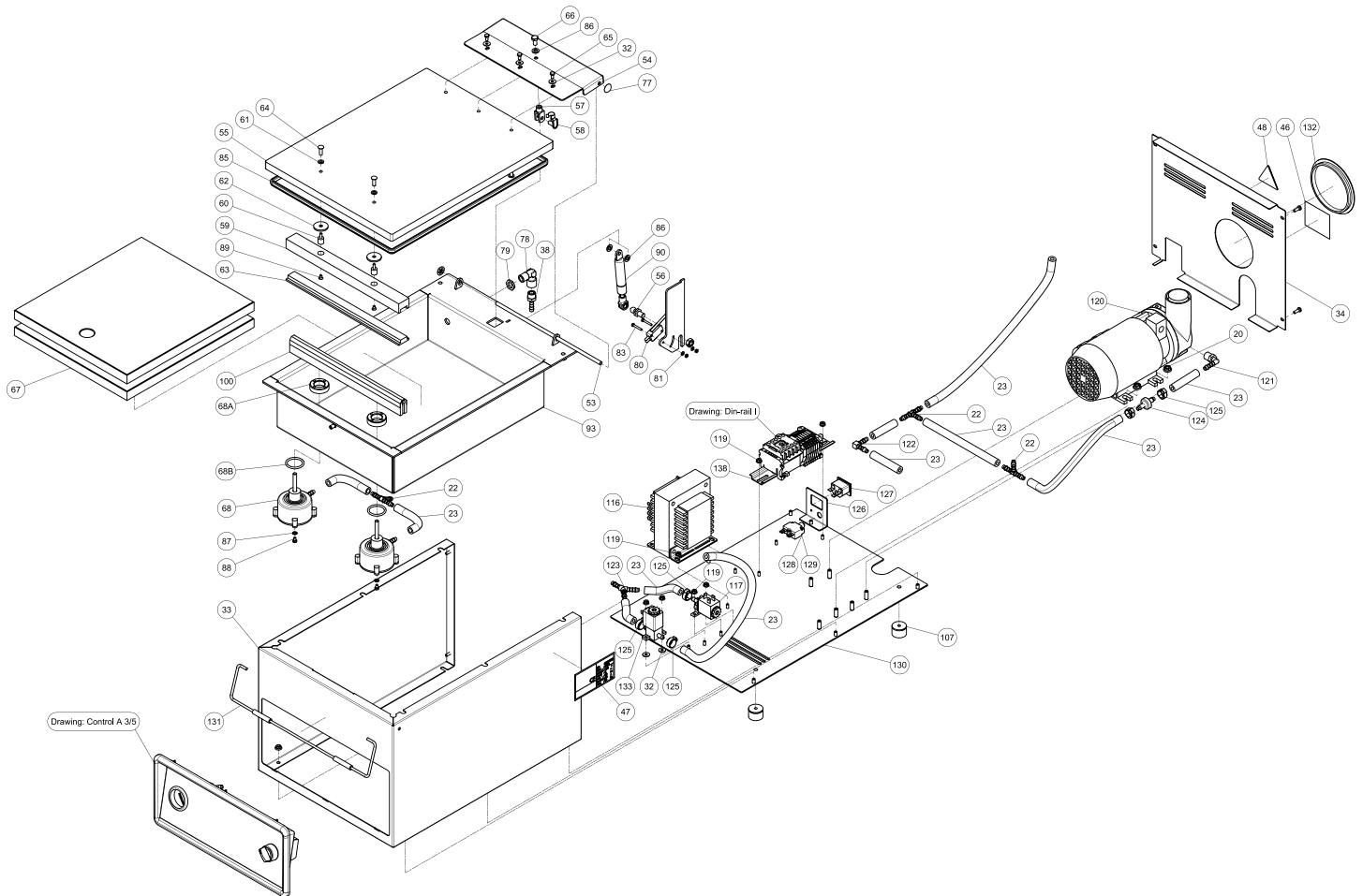

Parts Breakdown

Model VP-NL-0004-S 50006

Model VP-NL-0008-S 50007

Item No.	Description	Position	Item No.	Description	Position	Item No.	Description	Position
27781	Hexagon Flangenut M6 Din6923 A2 for 50006, 50007	20	30004	Hexagon Screw M4x8 Din 933 A2 for 50006, 50007	65	15718	Decompress Valve 303500 for 50006, 50007	117
27836	Connecting Piece T-Piece 6mm for 50006, 50007	22	30005	Hexagon Screw M6x12 Din933 A2 for 50006, 50007	66	35041	Hose Clip Klemfa 12.8x14.8mm for 50006, 50007	119
27837	Hose (O2) Drago 6x13 for 50006, 50007	23	30006	Insert Plate 120/140-ST for 50006, 50007	67	30014	Vacuum Pump 004-316 220/240-1-50/60 for 50006, 50007	120
34998	Flat Washer M4 D9021 A2 for 50006, 50007	32	30007	Seal Cylinder 305500 for 50006, 50007	68	30015	Square Hose Coupling 1/4"x6 Ext. for 50006, 50007	121
29995	Bottom Section 120/140-ST for 50006, 50007	33	30007	Seal Cylinder 305500 for 50006, 50007	68A	30016	Square Connect Piece 6mm for 50006, 50007	122
29996	Backplate 120/140-ST for 50006, 50007	34	30007	Seal Cylinder 305500 for 50006, 50007	68B	30017	Y Connecting Piece 6mm for 50006, 50007	123
29997	Brass Hose Coupling 1/4"x6 Ext. for 50006, 50007	38	27810	Spring Ring with Cover 6mm for 50006, 50007	77	63991	Non-Return Valve 8mm for 50006, 50007	124
27796	Sticker Oil for 50006, 50007	46	30009	Elbow 1/4" Int/Ext Brass for 50006, 50007	78	30019	Hose Clip Klemfa 12.8x14.8mm for 50006, 50007	125
27794	Sticker Machine Type for 50006, 50007	47	30010	Brass Nut 1/4" for 50006, 50007	79	30020	Holder Net Entree STF-42 for 50006, 50007	126
27795	Sticker Tension Triangle for 50006, 50007	48	15775	Micro Switch MV3003L for 50006, 50007	80	27791	Net Entree Male Snap-In STF42 for 50006, 50007	127
29998	Hinge Bearing ST.ST. 6x255 for 50006, 50007	53	27822	Castle Washer M3 for 50006, 50007	81	30021	Thermal Fuse 4A for 50006, 50007	128
29999	Hinge Part for 50006, 50007	54	30011	Slotted Cheese Head Screw M3x20 A2 Din84 for 50006, 50007	83	30022	Thermal Fuse 8A for 50006, 50007	129
30000	Vacuum Cover 120/140-ST for 50006, 50007	55	35291	Silicone Profile Cover 5.5mm L=1MTR for 50006, 50007	85	30023	Bottom Plate 120/140-ST for 50006, 50007	130
30001	Balltap 03/ACR L=12 for 50006, 50007	56	27824	Castle Washer M6 for 50006, 50007	86	30024	Lid Locker 120/140-ST for 50006, 50007	131
27808	Adjusting Fork for 50006, 50007	57	27829	V-Ring Vertand M4 DIN 6798-A for 50006, 50007	87	30025	Closing Plug GPN 120/140-ST for 50006, 50007	132
27809	Adjusting Fork Closing Pin for 50006, 50007	58	27830	Slotted Cheese Head Screw M4x6 A2 Din84 for 50006, 50007	88	15717	3-Way Valve 500260 for 50006, 50007	133
30002	Silicon Holder 120/140-ST for 50006, 50007	59	30012	Slott.Countersunk Head Screw M4x6 Din963 A2 for 50006, 50007	89	27814	Hexagon Nut M8 Din934 A2 for 50006, 50007	134
35085	Vibration Absorber Silicon Holder ACR. Cover for 50006, 50007	60	17253	Lid Shock Cylinder for 50006, 50007	90	27823	Hexagon Nut M3 Din934 A2 for 50006, 50007	135
27804	Rubber Washer 10x5x1 for 50006, 50007	61	15884	Sealbeam Standard Compact Complete for 50006, 50007	100	30026	Slott.Rais.Counter.Head Screw M4x12 Din7985 A2 for 50006, 50007	136
15853	Ring Nylon (33-5) for 50006, 50007	62	35063	Vibration Absorber Foot for 50006, 50007	107	27839	Assembly Control A 3/5 for 50006, 50007	137
15842	Silicone T-Profiel 40 Shore One Meter for 50006, 50007	63	27782	Hexagon Flangenut M5 Din6923 A2 for 50006, 50007	108	30028	Din-Conductor I 220-240V-1~ Assemb. for 50006, 50007	138
15701	Book Screw Brass 350/15 for 50006, 50007	64	35039	Y Connecting Piece 6mm for 50006, 50007	116			

Parts Breakdown

Model VP-NL-0016-S 50008

Model VP-NL-0021-S 50009

Model VP-NL-0016-LL 50010

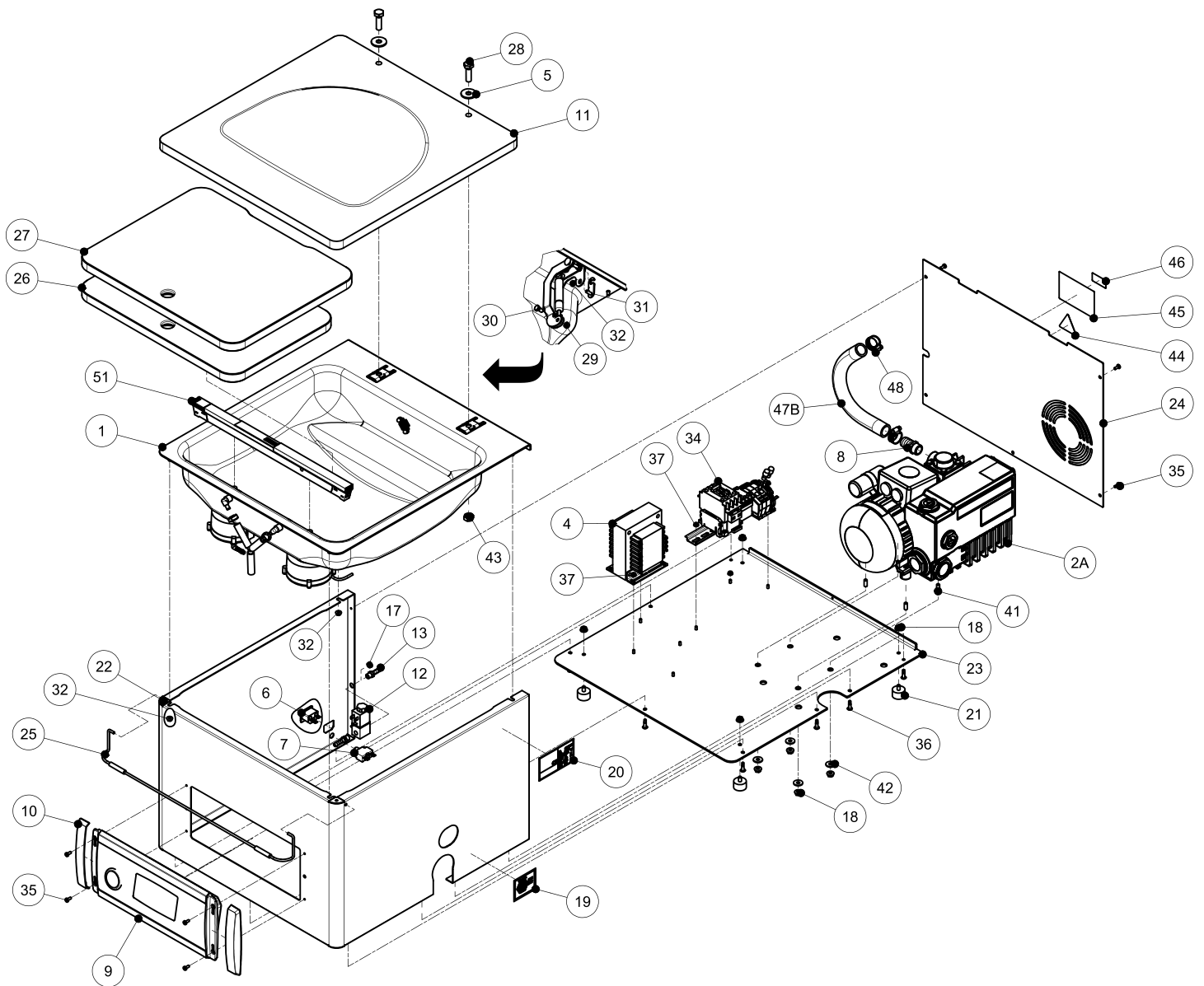

Parts Breakdown

Model VP-NL-0016-S 50008

Model VP-NL-0021-S 50009

Model VP-NL-0016-LL 50010

Item No.	Description	Position	Item No.	Description	Position	Item No.	Description	Position
65851	T4 Vacuumbak for 50008, 50009, 50010	1	65846	Elma Afdeknop 040-3020 ZWART for 50008, 50009, 50010	17	65838	DIN Rail D 1Fase for 50008, 50009, 50010	34C
35064	Pump 016E-220/240-1-50/60 for 50008, 50009, 50010	2A	27781	Hexagon Flangenuit M6 DIN6923 A2 for 50008, 50009, 50010	18	27789	Slott.Rais.Counter.Head Screw M4x10 DIN7985 A2 for 50008, 50009, 50010	35
35218	Vac.Pump 021-336 220/240-1-50 for 50008, 50009, 50010	2B	27796	Sticker Oil for 50008, 50009, 50010	19	65836	Hucknagel Magna-Lok MGLP-B6-4 for 50008, 50009, 50010	36
35039	Y Connectingpiece 6mm for 50008, 50009, 50010	4	27794	Sticker Machinetype for 50008, 50009, 50010	20	35041	Hose Clip Klemfa 12.8x14.8mm for 50008, 50009, 50010	37
27827	Flat Washer M10 D9021 A2 for 50008, 50009, 50010	5	65834	Vibration Absorber D=25 H=17 M6x10 for 50008, 50009, 50010	21	35219	Flat Washer M8 D9021 A2 for 50008, 50009, 50010	39
27791	Net Entree Male Snap-In STF42 for 50008, 50009, 50010	6	65854	T4 Omkasting for 50008, 50009, 50010	22	35220	Hexagon Screw M8x10 DIN933 A2 for 50008, 50009, 50010	40
35216	Thermal Fuse 6A for 50008, 50009, 50010	7A	65855	T4 Bodemplaat for 50008, 50009, 50010	23	65839	M6x16 Hexagon Socket Set Screw DIN 916 for 50008, 50009, 50010	41
30022	Thermal Fuse 8A for 50008, 50009, 50010	7B	65856	T4 Achterwand for 50008, 50009, 50010	24	27786	Flat Washer M6 D9021 A2 for 50008, 50009, 50010	42
35074	Thermal Fuse 10A for 50008, 50009, 50010	7C	65857	T4 Dekselsluiting for 50008, 50009, 50010	25	35978	Hexagon Nut M10 DIN934 A2 for 50008, 50009, 50010	43
65748	Slangpilaar G1-2x19mm BU for 50008, 50009, 50010	8	65858	T4 Inlegplaat Onder for 50008, 50009, 50010	26	27795	Sticker Tension Triangle for 50008, 50009, 50010	44
45858	Control Panel (Holder Wide + PCB/TV/1-PROG) for 50008, 50009, 50010	9	65859	T4 Inlegplaat Boven for 50008, 50009, 50010	27	35224	Sticker 98x65 Yellow for 50008, 50009, 50010	45
65740	Cap Small Holder 04-Control for 50008, 50009, 50010	10	65845	M10x35 Hex-Head Bolt DIN 933 for 50008, 50009, 50010	28	35223	Sticker 19x38 Yellow for 50008, 50009, 50010	46
45626	Lid/Cover T4 for 50008, 50009, 50010	11	65749	M6 Hex Nut DIN 985 for 50008, 50009, 50010	29	65862	T4-21m3 Pomp slang for 50008, 50009, 50010	47A
35285	Valve 2/2 MA-222-003-P27-SAH 24 for 50008, 50009, 50010	12	30005	Hexagon Screw M6x12 DIN933 A2 for 50008, 50009, 50010	30	65863	T4-16m3 Pomp slang for 50008, 50009, 50010	47B
35207	Brass Hose Coupling 1/8x6 Ext. for 50008, 50009, 50010	13	65860	Scharnier Afstelplaat 6mm AS for 50008, 50009, 50010	31	27835	Hose Clip ABA 15-24mm for 50008, 50009, 50010	48
65853	T-Stuk G 1 8 BI for 50008, 50009, 50010	14	27782	Hexagon Flangenuit M5 DIN6923 A2 for 50008, 50009, 50010	32	63995	Sealbalk TS-3-420 for 50008, 50009, 50010	51A
35204	Elbow 1/8 Int/Ext Brass for 50008, 50009, 50010	15	65837	DIN Rail C 1Fase (1-Program) for 50008, 50009, 50010	34A	63994	Sealbeam DS/3/420 for 50008, 50009, 50010	51B
35205	Brass Double Nipple 1/8 for 50008, 50009, 50010	16	65861	DIN Rail E 1Fase for 50008, 50009, 50010	34B			

Electrical Schematics

Model VP-NL-0004-S 50006

Model VP-NL-0008-S 50007

Model VP-NL-0016-S 50008

Model VP-NL-0021-S 50009

Model VP-NL-0016-LL 50010

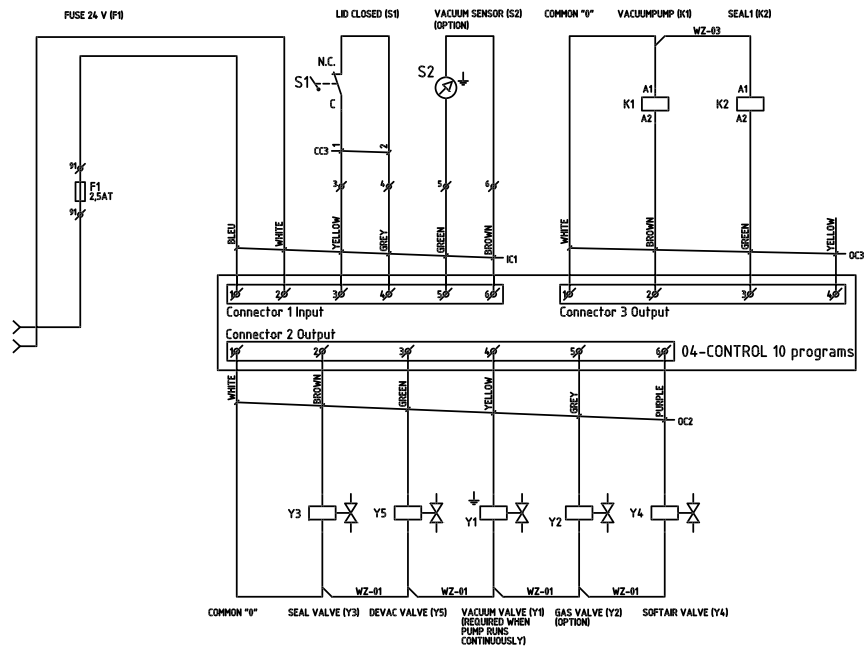
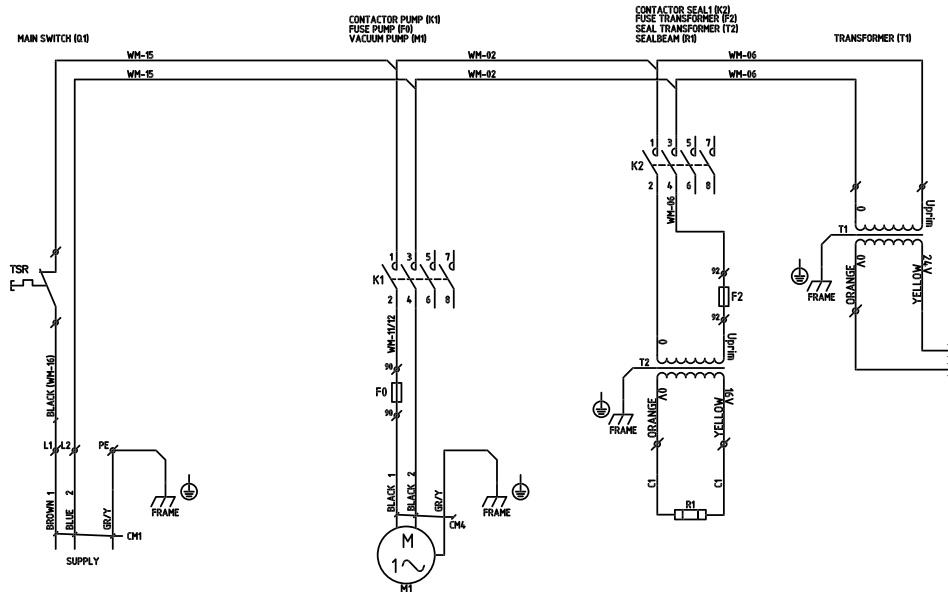

Notes



Warranty Registration

Thank you for purchasing an Omcan product. To register your warranty for this product, complete the information below, tear off the card at the perforation and then send to the address specified below. You can also register online by visiting:

Merci d'avoir acheté un produit Omcan. Pour enregistrer votre garantie pour ce produit, complétez les informations ci-dessous, détachez la carte au niveau de la perforation, puis l'envoyer à l'adresse spécifiée ci-dessous. Vous pouvez également vous inscrire en ligne en visitant:

Gracias por comprar un producto Omcan usted. Para registrar su garantía para este producto, complete la información a continuación, cortar la tarjeta en la perforación y luego enviarlo a la dirección indicada a continuación. También puede registrarse en línea en:

<https://omcan.com/warranty-registration/>

For mailing in Canada

Pour postale au Canada

Por correo en Canadá

OMCAN

PRODUCT WARRANTY REGISTRATION

3115 Pepper Mill Court,

Mississauga, Ontario

Canada, L5L 4X5

For mailing in the US

Pour diffusion aux États-Unis

Por correo en los EE.UU.

OMCAN

PRODUCT WARRANTY REGISTRATION

4450 Witmer Industrial Estates, Unit 4,

Niagara Falls, New York

USA, 14305

or email to: service@omcan.com



Purchaser's Information

Name: _____

Address: _____

City: _____ Province or State: _____ Postal or Zip: _____

Country: _____

Dealer from which Purchased: _____

Dealer City: _____ Dealer Province or State: _____

Invoice: _____

Model Name: _____ Model Number: _____

Machine Description: _____

Date of Purchase (MM/DD/YYYY): _____

Would you like to extend the warranty? Yes No

Company Name: _____

Telephone: _____

Email Address: _____

Type of Company:

Restaurant Bakery Deli

Butcher Supermarket Caterer

Institution (*specify*): _____

Other (*specify*): _____

Serial Number: _____

Date of Installation (MM/DD/YYYY): _____

Thank you for choosing Omcan | Merci d'avoir choisi Omcan | Gracias por elegir Omcan



Since 1951 Omcan has grown to become a leading distributor of equipment and supplies to the North American food service industry. Our success over these many years can be attributed to our commitment to strengthen and develop new and existing relationships with our valued customers and manufacturers. Today with partners in North America, Europe, Asia and South America, we continually work to improve and grow the company. We strive to offer customers exceptional value through our qualified local sales and service representatives who provide convenient access to over 6,500 globally sourced products.

Depuis 1951 Omcan a grandi pour devenir un des “leaders” de la distribution des équipements et matériel pour l’industrie des services alimentaires en Amérique du Nord. Notre succès au cours de ces nombreuses années peut être attribué à notre engagement à renforcer et à développer de nouvelles et existantes relations avec nos clients et les fabricants de valeur. Aujourd’hui avec des partenaires en Amérique du Nord, Europe, Asie et Amérique du Sud, nous travaillons continuellement à améliorer et développer l’entreprise. Nous nous efforçons d’offrir à nos clients une valeur exceptionnelle grâce à nos ventes locales qualifiées et des représentants de service qui offrent un accès facile à plus de 6500 produits provenant du monde entier.

Desde 1951 Omcan ha crecido hasta convertirse en un líder en la distribución de equipos y suministros de alimentos en América del Norte industria de servicios. Nuestro éxito en estos años se puede atribuir a nuestro compromiso de fortalecer y desarrollar nuevas relaciones existentes con nuestros valiosos clientes y fabricantes. Hoy con socios de América del Norte, Europa, Asia y América del Sur, que trabajan continuamente para mejorar y crecer la empresa. Nos esforzamos por ofrecer a nuestros clientes valor excepcional a través de nuestro local de ventas y representantes de los servicios que proporcionan un fácil acceso a más de 6,500 productos con origen a nivel mundial.

